



PELHAM & WHITE
Model: PWW101-A

MINIMUM CABINET SIZE:
AT LEAST
33" WIDE

Unpack and inspect your sink upon delivery to avoid costly contractor delays

Product Features

- High quality 16-Gauge 304 stainless steel alloy
- Sound deadening rubber pads and undercoating
- 10mm/0.4" radius corners for easy cleaning
- Includes finish matched stainless steel wire grid
- Includes finish matched stainless steel strainer drain



This sink is intended only for under-counter installations of solid-surface composite or natural stone countertops. It should never be installed in laminated countertops. Thus, specialized tools are required. It is highly recommended that this product be installed by professionals.



Observe all applicable plumbing codes in your municipality

Rough-In Dimensions

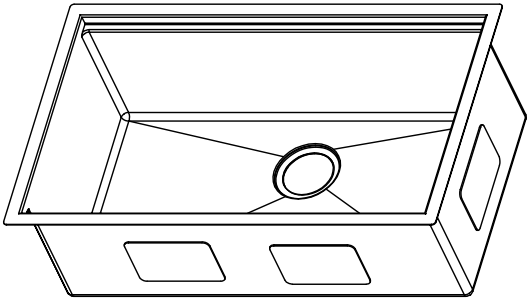
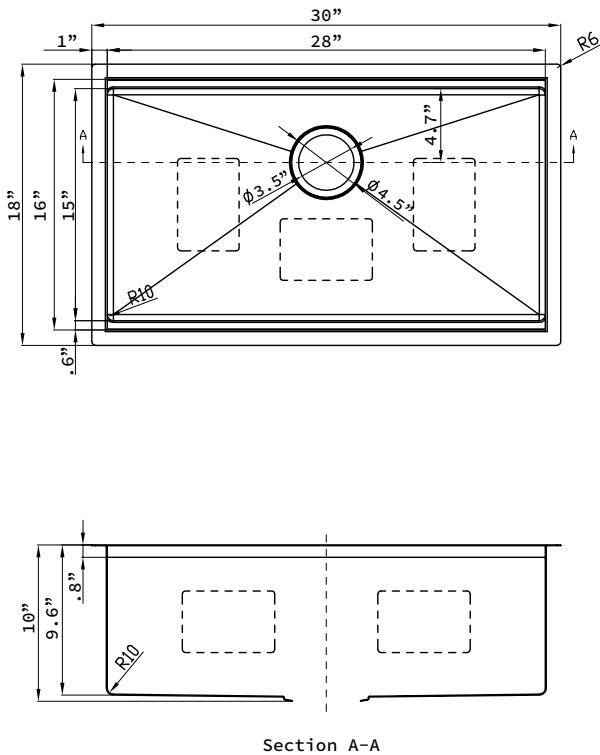



This sink is intended only for under-counter installations of solid-surface composite or natural stone countertops. It should never be installed in laminated countertops. Thus, specialized tools are required. It is highly recommended that this product be installed by professionals.

Installation

Observe all applicable plumbing codes in your municipality

Installer:

Template supplied with product is for reference only. Be sure to double check with the actual sink before cutting opening. Be sure to properly allow clearance for the mounting hardware, faucet, and other sink accessories.

Mounting anchors and brackets have been supplied with this product, but it is always best to use your own preferred methods of sink securement and attachment, given the different applications and countertop materials that may be involved.

Mounting the faucet to the countertop before installing sink is highly recommended.

Underside of Countertop

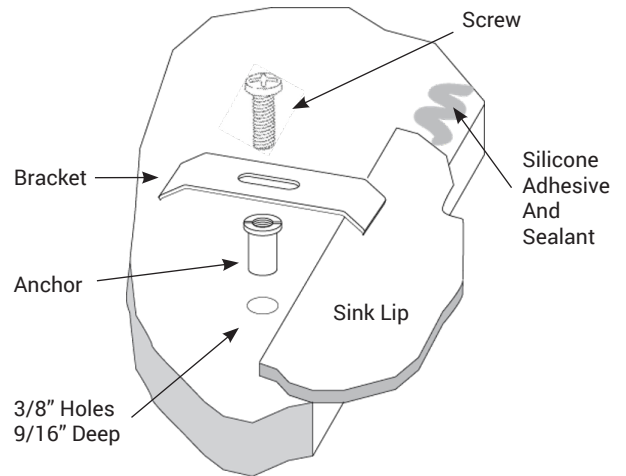

Care

Stainless steel sinks are durable, but they do benefit from proper care. If you want your sink to always look it's best we recommend the following :

- Clean using a non-abrasive, mild detergent.
- Use only a sponge or soft cloth for cleaning.
- Avoid using steel wool for cleaning anything within the sink.
- Remove any cast iron or steel pans promptly after cleaning.
- Keep the sink clean, dry and empty when not in use.
- Don't leave sponges and other wet items in the sink.
- If you want to avoid water spots, wipe your sink dry after each use.

Warranty

Limited lifetime warranty on residential applications or limited one year for commercial applications extended to the original purchaser or owner covering defects in material and workmanship. Excluded is damage done to the surface by disregarding the care recommendations provided in the installation instructions, or improper installation. This warranty does not cover products not installed by a qualified professional installer. Warranty covers replacement of the defective product only and does not cover installation or other consequential costs or damages.

Pelham & White reserves the right to make specification and pricing changes without notice or obligation, and to change or discontinue models and finishes



PELHAM & WHITE

548 South Columbus Avenue • Mount Vernon, New York 10550
1-855-561-5222 • www.pelhamandwhite.com

(09/10/21) All rights reserved. Copyright Pelham & White 2021.

Single-Handle Pull-Down Sprayer

Model: FP4AF222

Product Features

- Stainless steel PVD finish
- Ceramic disc cartridge
- Dual-mode metal sprayer
- Lever style handle
- Integrated supply lines with 3/8" compression connections
- Max flow rate: 1.8 GPM @ 60 PSI



BEFORE INSTALLATION / ANTES DE LA INSTALACIÓN

If you contact Customer Service, you will need the Model#, Serial Number and Date Code.

Please locate the Product ID tag and Serial number tag.

Please record the serial number and date code here

BEFORE YOU INSTALL:

Serial Number

Date Code

Please attach your receipt for proof of purchase.

Si se comunica con Servicio al Cliente, necesitará el modelo #, número de serie y código de fecha.

Por favor, busque la etiqueta de identificación del producto y la etiqueta del número de serie.

Anote el número de serie y el código de fecha aquí

ANTES DE INSTALAR:

número de serie

Fecha Código

Adjunte su recibo como prueba de compra.

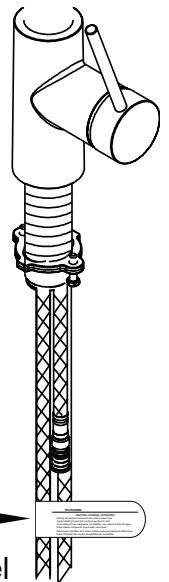

Product ID tag can be found on the hot supply line.

Las etiquetas de identificación del grifo se encontrarán en la tubería de alimentación de agua caliente.

MOUNT FAUCET / GRIFO DE MONTAJE

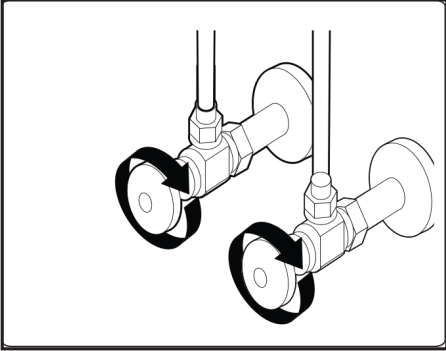

Turn off water supplies
Cierra los suministros de agua

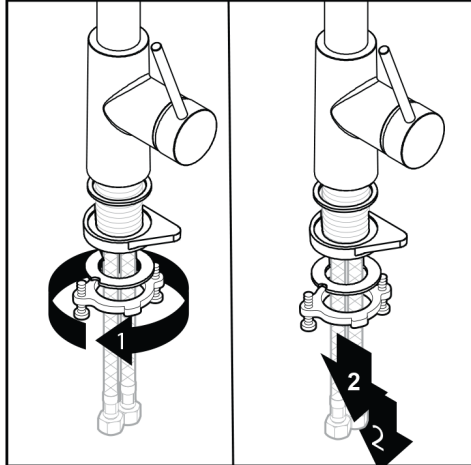

Remove hardware
Quitar hardware

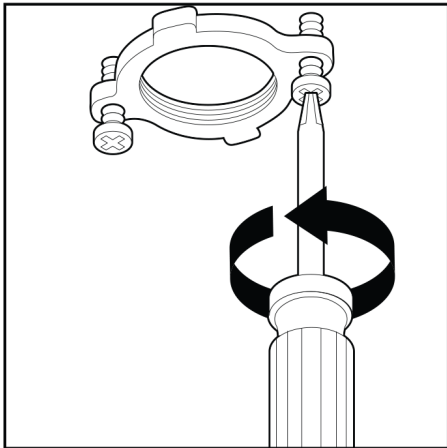
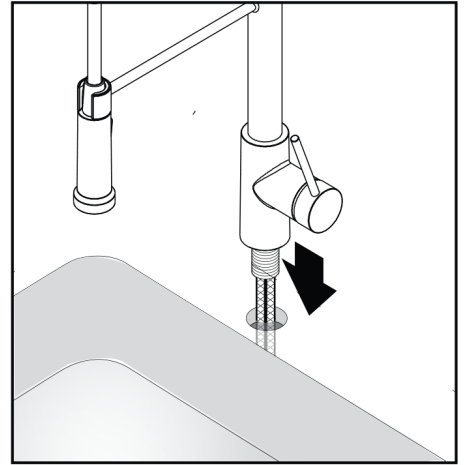

Unscrew the pre-assembled guide washer screws on guide washer until they are flush with the face of the guide washer.

Retire los tornillos preensamblados en la arandela guía hasta que estén al ras con la cara de la arandela guía.

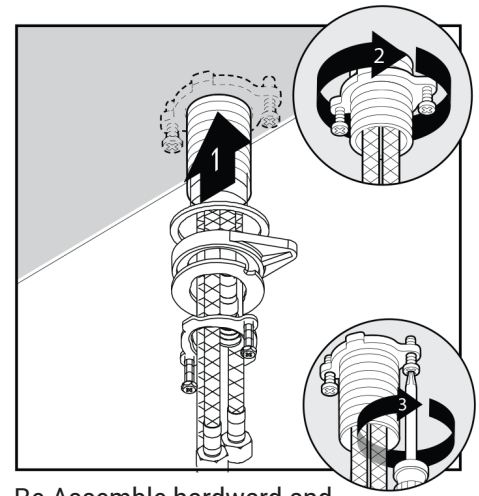

Re-Assemble hardware and tighten

Reensamble los herrajes y apriete

CONNECT FAUCET FLUSH LINES AND TEST / CONECTE LAS LÍNEAS DE DESCARGA DEL GRIFO Y PRUEBE

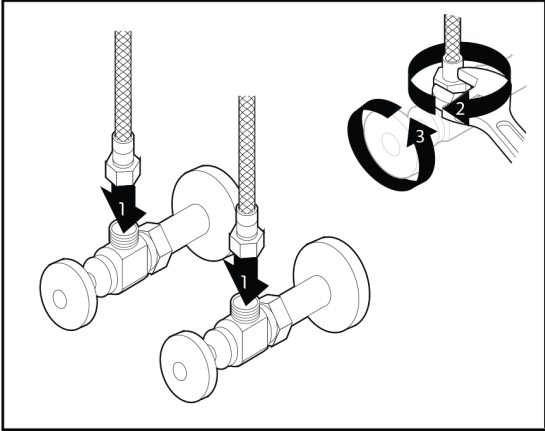

Connect supply hoses
Conecte las mangueras de suministro

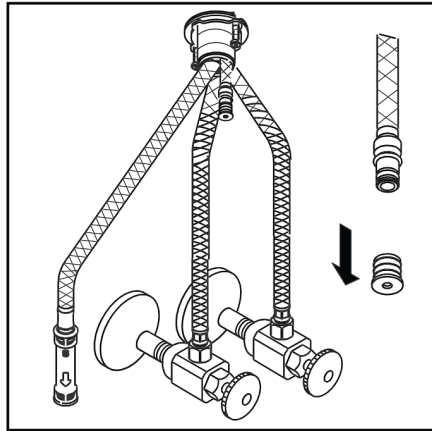

Remove cap
Quite la tapa

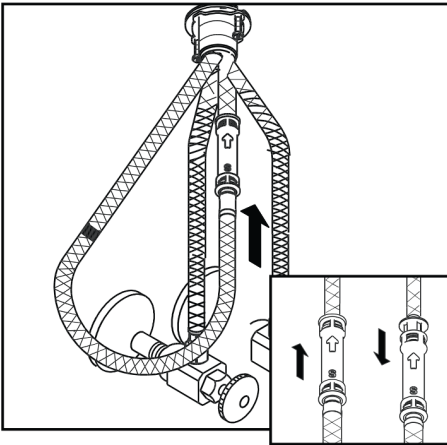

PUSH to Connect
PULSAR para conectar

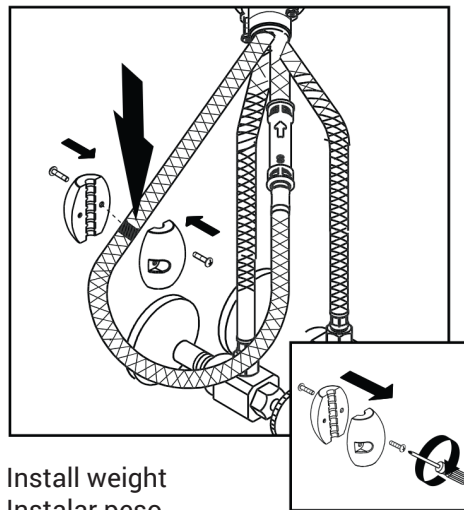

Install weight
Instalar peso

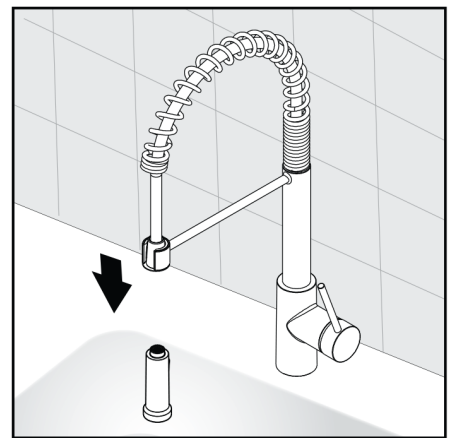

Remove Sprayer
Quitar pulverizador

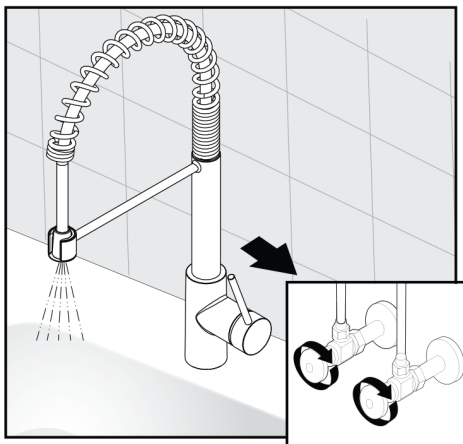

Turn on water and flush lines
Encienda el agua y las líneas de descarga

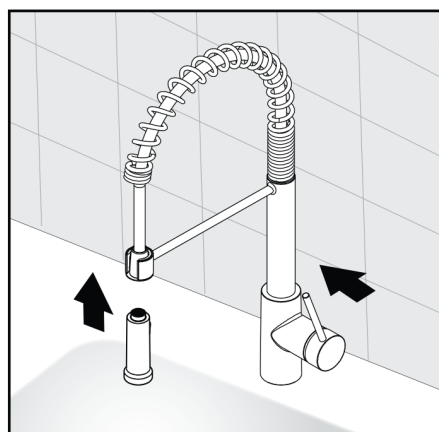

Replace Sprayer
Reemplace el pulverizador

TROUBLESHOOTING / SOLUCIÓN DE PROBLEMAS

PROBLEM PROBLEMA	POSSIBLE CAUSE CAUSA POSIBLE	CORRECTIVE ACTION ACCIÓN CORRECTIVA
<p>Leak from under handle. Goteo debajo de la llave.</p>	<p>Damaged cartridge. El cartucho está dañado.</p>	<p>Remove handle. Replace cartridge. Retire la manija. Reemplace el cartucho.</p>
<p>Inconsistent water flow pattern. El flujo de agua es irregular.</p>	<p>Cartridge needs to be replaced. Se necesita reemplazar el cartucho.</p>	<p>Remove handle assembly, trim cap and locking nut. Take out existing cartridge and discard. Replace with new cartridge and reassemble. Retire el ensamble de la manija, la tapa para el reborde y la contratuerca. Saque el cartucho existente y deséchelo. Reemplácelo por un nuevo cartucho y vuelva a ensamblar.</p>

CARE AND MAINTENANCE / CUIDADO Y MANTENIMIENTO

- Clean periodically with a soft cloth. Avoid abrasive cleaners, steel wool, and harsh chemicals as these will dull the finish and void your warranty.
- Limpie periódicamente con un paño suave. Evite utilizar limpiadores abrasivos, lana de acero y químicos agresivos, ya que pueden dañar el acabado y anular la garantía.

WARRANTY / GARANTÍA

The manufacturer warrants this faucet to be free from defects in workmanship and material present at time of shipment from the factory for a limited lifetime from the date of purchase. This warranty applies only to the original purchaser. The manufacturer agrees to correct such defects at no charge or, at our option, replace the faucet with a comparable or superior model. You may be required to present a copy of your sales receipt as proof of purchase. All cost of removal and reinstallation are the expressed responsibility of the purchaser. Any damage to the faucet by accident, misuse or improper installation, or by affixing accessories not produced by the manufacturer, are the purchaser's responsibility. The manufacturer assumes no responsibility whatsoever for faucet installation during the warranty period. There is no further expressed warranty. The manufacturer disclaims any and all implied warranties. The manufacturer shall not be liable for incidental, consequential or special damages arising at or in connection with product use or performance except as may otherwise be accorded by law. This warranty gives you specific legal rights, and you may also have other rights which vary from state to state, province to province. This warranty supersedes all prior warranties.

El fabricante garantiza que este grifo no presenta defectos en la mano de obra ni en los materiales presentes en el momento del transporte desde la fábrica durante un período limitado de por vida a partir de la fecha de compra. Esta garantía es válida sólo para el comprador original. El fabricante acepta reparar dichos defectos sin cargo o, según nuestro criterio, reemplazar el grifo por un modelo comparable o superior. Es posible que se le exija presentar una copia del recibo de venta como comprobante de compra. Todos los costos de extracción y reinstalación son de responsabilidad explícita del comprador. Cualquier daño al grifo producido por accidente, uso indebido o instalación incorrecta, o a causa del uso de elementos accesorios que no son del fabricante, será responsabilidad del comprador. El fabricante no asume ningún tipo de responsabilidad por la instalación del grifo durante el período de garantía. No existe otro tipo de garantía explícita. El fabricante rechaza cualquiera y todas las garantías implícitas. El fabricante no se hará responsable por daños accidentales, resultantes o especiales que surjan en relación con el uso o el funcionamiento del producto, excepto que la ley indique lo contrario. Esta garantía le otorga derechos legales específicos, pero podría tener también otros derechos que varían de estado/provincia a estado/provincia. Esta garantía sustituye cualquier garantía previa.

REPLACEMENT PARTS LIST / LISTA DE PIEZAS DE REPUESTO

For replacement parts, call our customer service department.

Para obtener piezas de repuesto, por favor póngase en contacto con Servicio al Cliente.

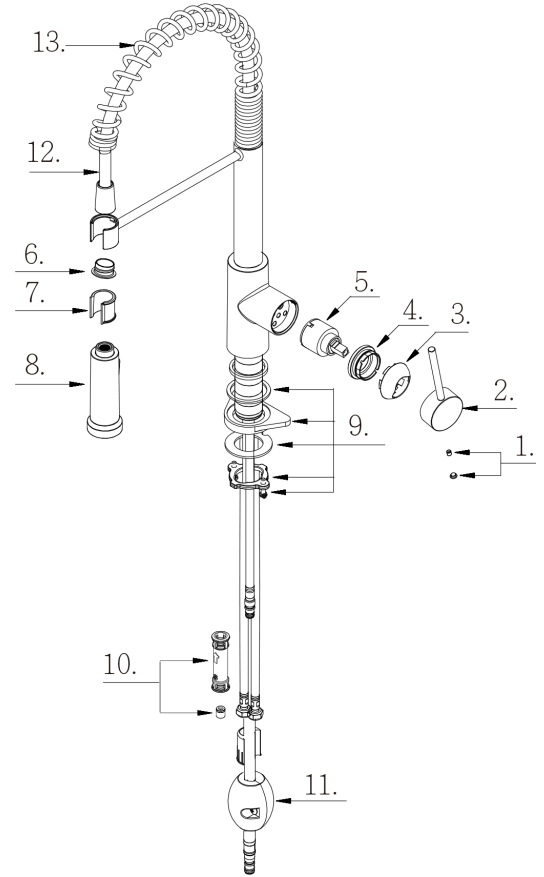

PART PIEZA	DESCRIPTION / DESCRIPCIÓN	PART # PIEZA #
1	Handle Cap Assembly / Ensamblaje del Tapón	94132-1
2	Metal Handle / Ensamblaje de manija metálicas	94132-2
3	Handle Trim Ring / Capuchón ornamental de la manija	94132-3
4	Adjusting Ring / Anillo de ajuste	94132-4
5	Ceramic Disc Cartridge / Cartucho de disco cerámico	94132-5
6	Hose Sleeve / Manguera de Manga	94132-6
7	Clip / Seguro	94132-7
8	Spray Head 1.75gpm / Cabezal del rociador 1.75gpm	94132-8
9	Mounting Hardware Assembly / Ferreteria de montaje	94132-9
10	Hose Adapter / Adaptador de manguera	94132-10
11	Weight / Pesas	94132-11
12	Spray Hose 67 " / Manguera del rociador 67 "	94132-12
13	Spring / Resorte	94132-13