



PELHAM & WHITE
Model: PWS230-B

MINIMUM CABINET SIZE:
AT LEAST
36" WIDE

Unpack and inspect your sink upon delivery to avoid costly contractor delays

Product Features

- High quality 16-Gauge 304 stainless steel alloy
- Sound deadening rubber pads and undercoating
- 10mm/0.4" radius corners for easy cleaning
- Includes finish matched stainless steel wire grid
- Includes finish matched stainless steel strainer drain



This sink is intended only for under-counter installations of solid-surface composite or natural stone countertops. It should never be installed in laminated countertops. Thus, specialized tools are required. It is highly recommended that this product be installed by professionals.



Observe all applicable plumbing codes in your municipality

Rough-In Dimensions

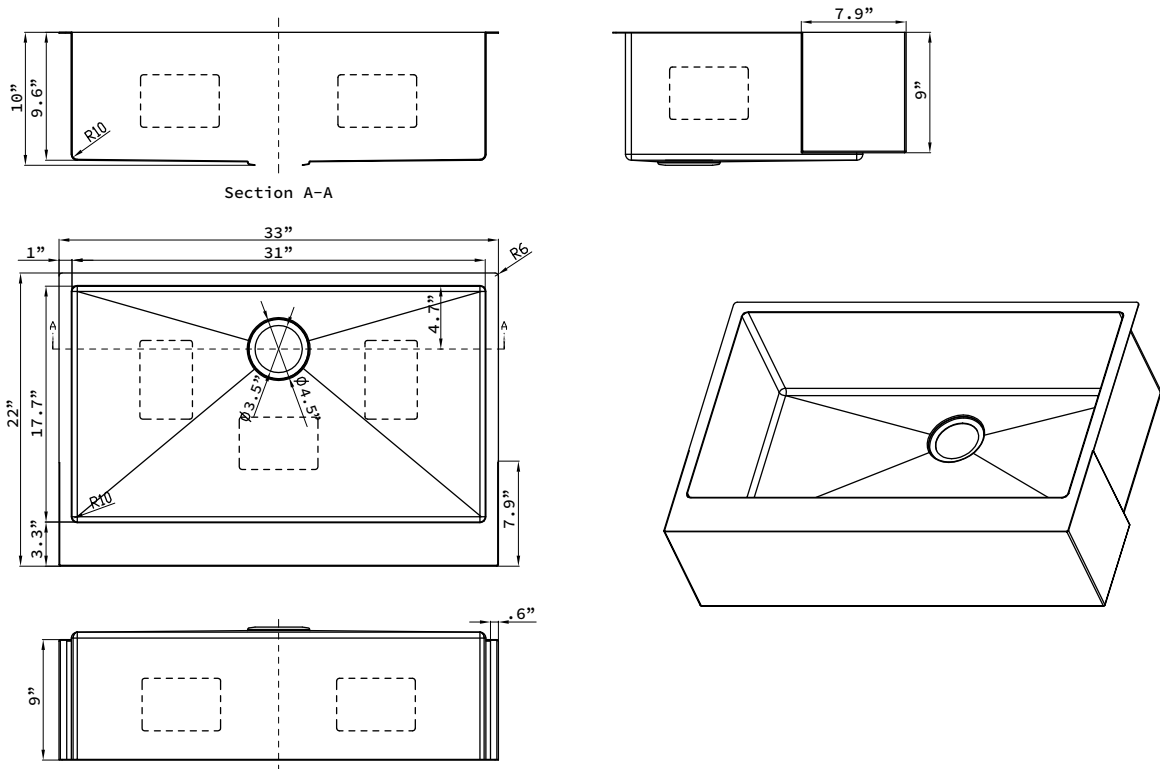

Single-Handle Pull-Down Sprayer

Model# PD230-SS
Stainless Steel PVD

Features

- Stainless steel PVD finish
- Ceramic disc cartridge
- Dual-mode metal sprayer
- Lever style handle
- Integrated supply lines with 3/8" compression connections
- Max flow rate: 1.8 GPM @ 60 PSI

Codes and Standards

Specified model meets or exceeds:

- ASME A112.18.1 / CSA B125.1
- NSF 61 Section 9
- IAPMO / UPC listed
- AB1953 low lead
- California Energy Commission Compliant
- ADA compliance to ANSI A117.1

Installation Notes

- Requires 1-1/4" min to 1-3/4" max hole diameter
- Maximum counter thickness: 1-7/8"
- Installs in 1, 2, 3, or 4 holes

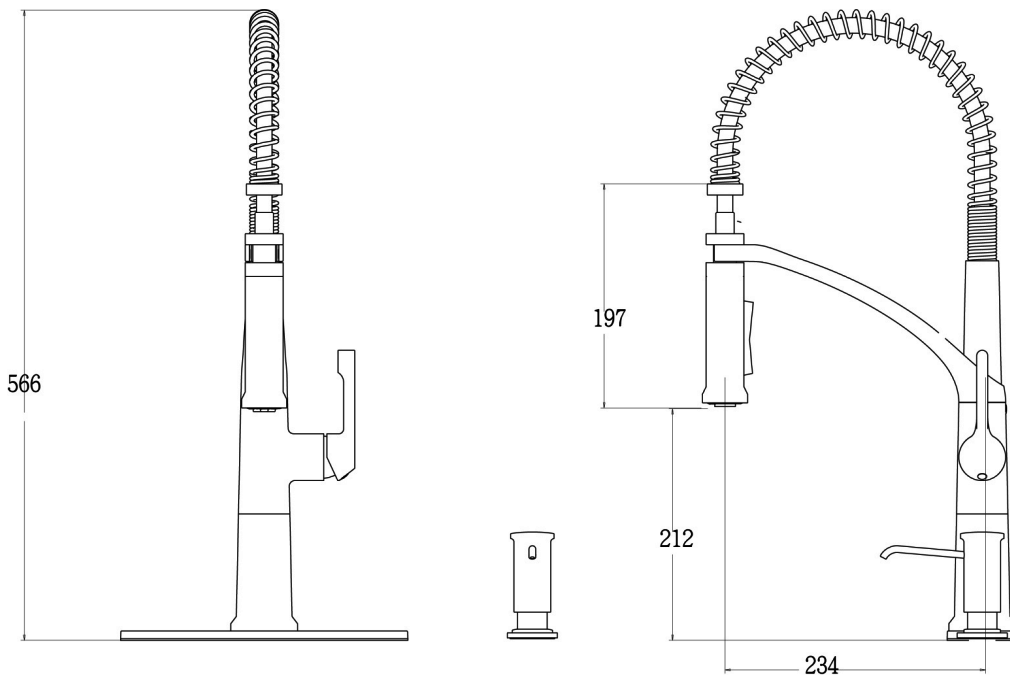

Warranty

The manufacturer warrants this faucet to be free from defects in workmanship and material present at time of shipment from the factory for a limited lifetime from the date of purchase. This warranty applies only to the original purchaser. The manufacturer agrees to correct such defects at no charge or, at our option, replace the faucet with a comparable or superior model. You may be required to present a copy of your sales receipt as proof of purchase. All cost of removal and reinstallation are the expressed responsibility of the purchaser. Any damage to the faucet by accident, misuse or improper installation, or by affixing accessories not produced by the manufacturer, are the purchaser's responsibility. The manufacturer assumes no responsibility whatsoever for faucet installation during the warranty period. There is no further expressed warranty. The manufacturer disclaims any and all implied warranties. The manufacturer shall not be liable for incidental, consequential or special damages arising at or in connection with product use or performance except as may otherwise be accorded by law. This warranty gives you specific legal rights, and you may also have other rights which vary from state to state, province to province. This warranty supersedes all prior warranties.