



PELHAM & WHITE
Model: PWS201-C

MINIMUM CABINET SIZE:
AT LEAST
33" WIDE

Unpack and inspect your sink upon delivery to avoid costly contractor delays

Product Features

- High quality 16-Gauge 304 stainless steel alloy
- Sound deadening rubber pads and undercoating
- 10mm/0.4" radius corners for easy cleaning
- Includes finish matched stainless steel wire grid
- Includes finish matched stainless steel strainer drain



This sink is intended only for under-counter installations of solid-surface composite or natural stone countertops. It should never be installed in laminated countertops. Thus, specialized tools are required. It is highly recommended that this product be installed by professionals.



Observe all applicable plumbing codes in your municipality

Rough-In Dimensions

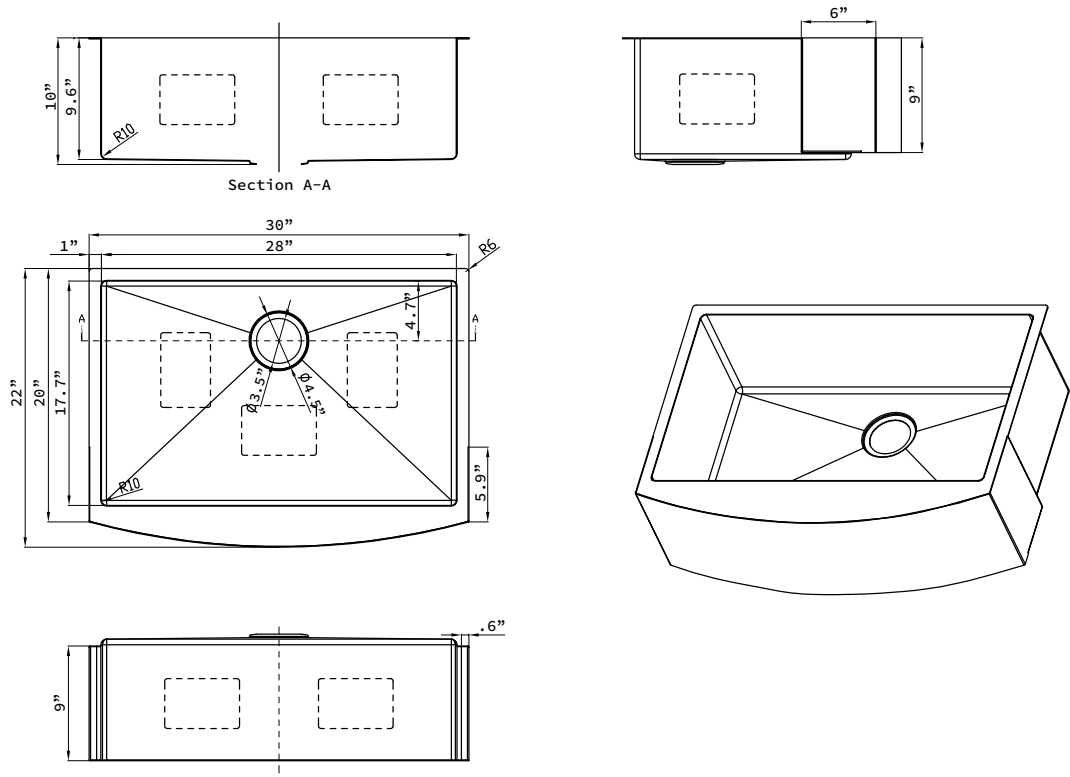



This sink is intended only for under-counter installations of solid-surface composite or natural stone countertops. It should never be installed in laminated countertops. Thus, specialized tools are required. It is highly recommended that this product be installed by professionals.

Installation

Observe all applicable plumbing codes in your municipality

Installer:

- The methods of installation for undermount and apron sinks are highly dependent on the countertop and cabinet materials, construction and dimensions
- If you are unfamiliar with the installation options and techniques for apron-styled sinks please do the proper research given the countertop material and cabinet applications specific to this jobsite
- Template supplied with product is for reference only
- Be sure to double check with the actual sink before cutting opening
- Be sure to properly construct a sturdy wood frame to support the sink and its contents when filled
- Be sure to secure the frame to the cabinet sides
- Silicone adhesive / sealant should be used between the sink and the countertop
- Mounting the faucet to the countertop before installing sink is highly recommended

It is always best to use your own preferred methods of sink securement and attachment, given the different applications and countertop materials that may be involved.

Care

Stainless steel sinks are durable, but they do benefit from proper care. If you want your sink to always look it's best we recommend the following :

- Clean using a non-abrasive, mild detergent.
- Use only a sponge or soft cloth for cleaning.
- Avoid using steel wool for cleaning anything within the sink.
- Remove any cast iron or steel pans promptly after cleaning.
- Keep the sink clean, dry and empty when not in use.
- Don't leave sponges and other wet items in the sink.
- If you want to avoid water spots, wipe your sink dry after each use.

Warranty

Limited lifetime warranty on residential applications or limited one year for commercial applications extended to the original purchaser or owner covering defects in material and workmanship. Excluded is damage done to the surface by disregarding the care recommendations provided in the installation instructions, or improper installation. This warranty does not cover products not installed by a qualified professional installer. Warranty covers replacement of the defective product only and does not cover installation or other consequential costs or damages.

Pelham & White reserves the right to make specification and pricing changes without notice or obligation, and to change or discontinue models and finishes



PELHAM & WHITE

548 South Columbus Avenue • Mount Vernon, New York 10550
1-855-561-5222 • www.pelhamandwhite.com

(09/10/21) All rights reserved. Copyright Pelham & White 2021.

HELPFUL TOOLS (NOT INCLUDED) / HERRAMIENTAS ÚTILES (NO SE INCLUYEN)

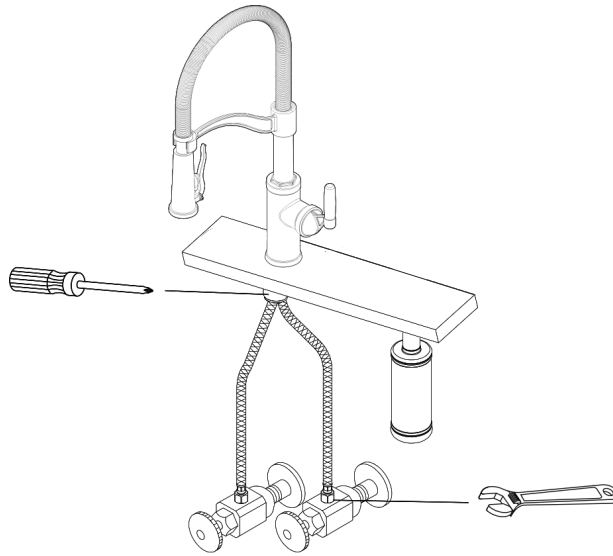

ASSEMBLY INSTRUCTIONS / INSTRUCCIONES DE ENSAMBLAJE

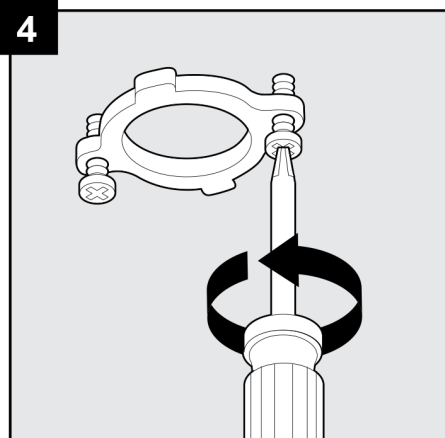
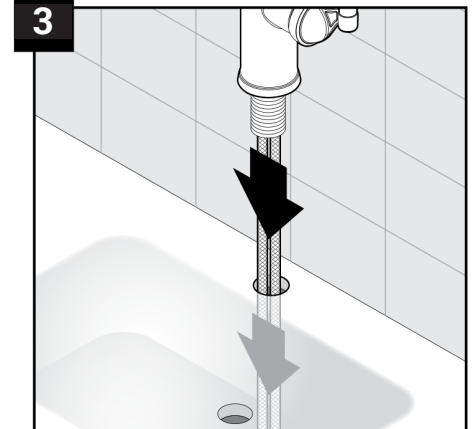
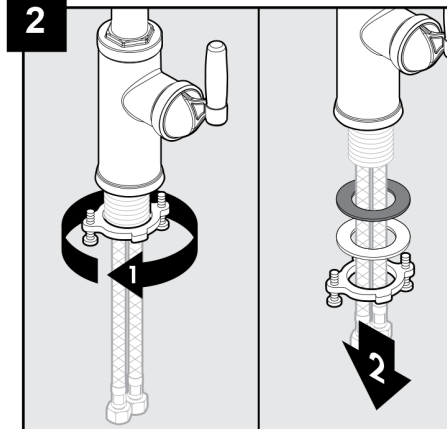
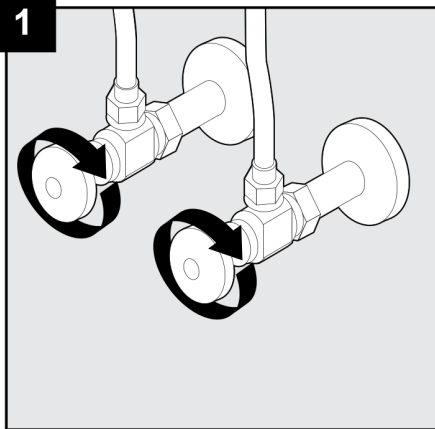

Unscrew the pre-assembled guide washer screws on guide washer until they are flush with the face of the guide washer.

Retire los tornillos preensamblados en la arandela guía hasta que estén al ras con la cara de la arandela guía.

ASSEMBLY INSTRUCTIONS / INSTRUCCIONES DE ENSAMBLAJE

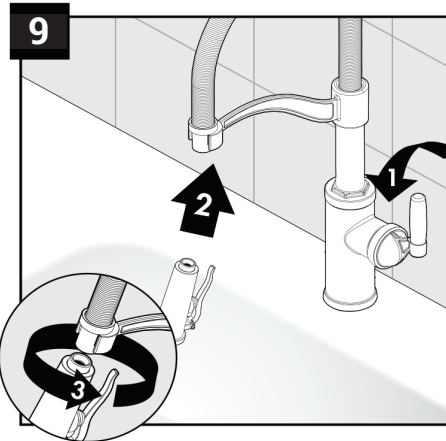
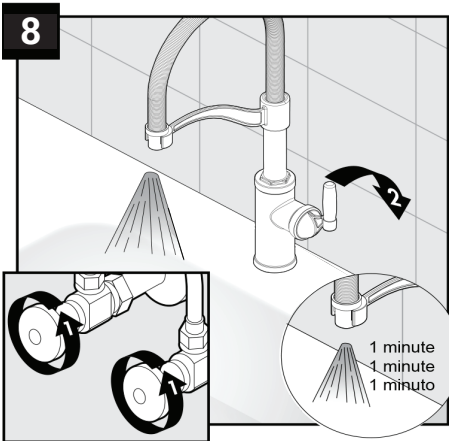
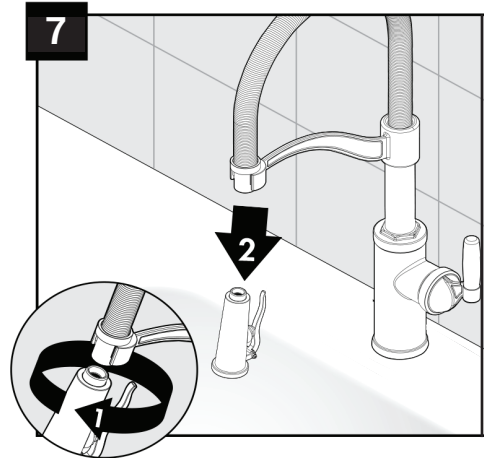
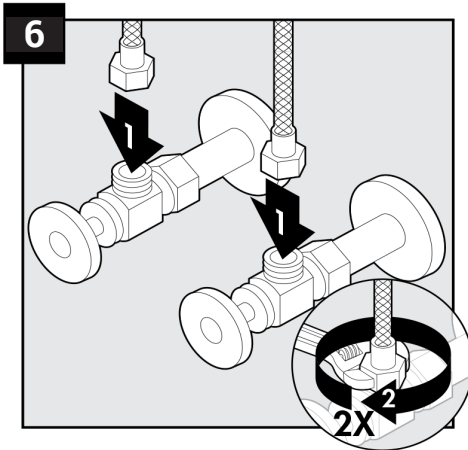
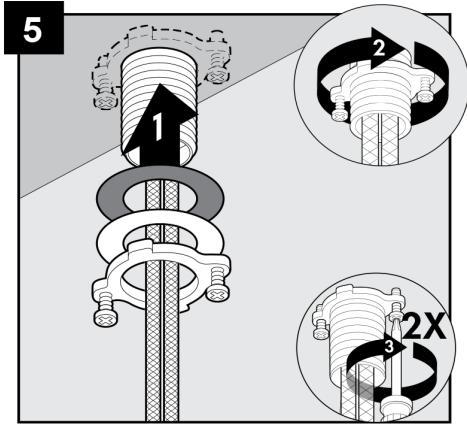

TROUBLESHOOTING / SOLUCIÓN DE PROBLEMAS

PROBLEM PROBLEMA	POSSIBLE CAUSE CAUSA POSIBLE	CORRECTIVE ACTION ACCIÓN CORRECTIVA
<p>Leak from under handle. Goteo debajo de la llave.</p>	<p>Damaged cartridge. El cartucho está dañado.</p>	<p>Remove handle. Replace cartridge. Retire la manija. Reemplace el cartucho.</p>
<p>Inconsistent water flow pattern. El flujo de agua es irregular.</p>	<p>Cartridge needs to be replaced. Se necesita reemplazar el cartucho.</p>	<p>Remove handle assembly, trim cap and locking nut. Take out existing cartridge and discard. Replace with new cartridge and reassemble. Retire el ensamble de la manija, la tapa para el reborde y la contratuerca. Saque el cartucho existente y deséchelo. Reemplácelo por un nuevo cartucho y vuelva a ensamblar.</p>

CARE AND MAINTENANCE / CUIDADO Y MANTENIMIENTO

- Clean periodically with a soft cloth. Avoid abrasive cleaners, steel wool, and harsh chemicals as these will dull the finish and void your warranty.
- Limpie periódicamente con un paño suave. Evite utilizar limpiadores abrasivos, lana de acero y químicos agresivos, ya que pueden dañar el acabado y anular la garantía.

WARRANTY / GARANTÍA

The manufacturer warrants this faucet to be free from defects in workmanship and material present at time of shipment from the factory for a limited lifetime from the date of purchase. This warranty applies only to the original purchaser. The manufacturer agrees to correct such defects at no charge or, at our option, replace the faucet with a comparable or superior model. You may be required to present a copy of your sales receipt as proof of purchase. All cost of removal and reinstallation are the expressed responsibility of the purchaser. Any damage to the faucet by accident, misuse or improper installation, or by affixing accessories not produced by the manufacturer, are the purchaser's responsibility. The manufacturer assumes no responsibility whatsoever for faucet installation during the warranty period. There is no further expressed warranty. The manufacturer disclaims any and all implied warranties. The manufacturer shall not be liable for incidental, consequential or special damages arising at or in connection with product use or performance except as may otherwise be accorded by law. This warranty gives you specific legal rights, and you may also have other rights which vary from state to state, province to province. This warranty supersedes all prior warranties.

El fabricante garantiza que este grifo no presenta defectos en la mano de obra ni en los materiales presentes en el momento del transporte desde la fábrica durante un período limitado de por vida a partir de la fecha de compra. Esta garantía es válida sólo para el comprador original. El fabricante acepta reparar dichos defectos sin cargo o, según nuestro criterio, reemplazar el grifo por un modelo comparable o superior. Es posible que se le exija presentar una copia del recibo de venta como comprobante de compra. Todos los costos de extracción y reinstalación son de responsabilidad explícita del comprador. Cualquier daño al grifo producido por accidente, uso indebido o instalación incorrecta, o a causa del uso de elementos accesorios que no son del fabricante, será responsabilidad del comprador. El fabricante no asume ningún tipo de responsabilidad por la instalación del grifo durante el período de garantía. No existe otro tipo de garantía explícita. El fabricante rechaza cualquiera y todas las garantías implícitas. El fabricante no se hará responsable por daños accidentales, resultantes o especiales que surjan en relación con el uso o el funcionamiento del producto, excepto que la ley indique lo contrario. Esta garantía le otorga derechos legales específicos, pero podría tener también otros derechos que varían de estado/provincia a estado/provincia. Esta garantía sustituye cualquier garantía previa.

REPLACEMENT PARTS LIST / LISTA DE PIEZAS DE REPUESTO

For replacement parts, call our customer service department.

Para obtener piezas de repuesto, por favor póngase en contacto con Servicio al Cliente.

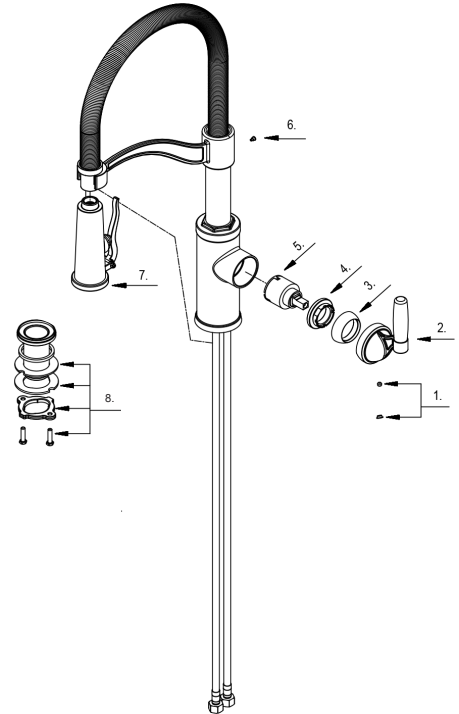

PART PIEZA	DESCRIPTION / DESCRIPCIÓN	PART # PIEZA #
1	Handle Cap Set / Juego de tapón	A66D558
2	Metal Handle Assembly / Ensamblaje de manija metálicas	A662406
3	Trim Cap / Tapa ornamental	A103016
4	Locking Nut / Contratuerca	A104207
5	Ceramic Disc Cartridge / Cartucho de disco cerámico	A507348N
6	Screw / Tornillo	A008217
7	Sprayer / Cabezal del rociador	A528034N-54
8	Mounting Hardware Assembly / Ensamblaje de ferretería de montaje	A603171