

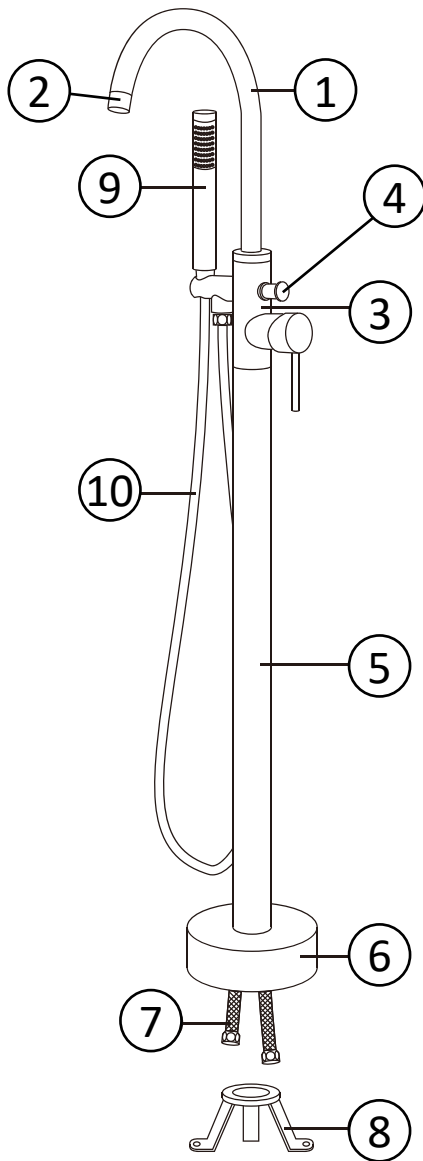

Due to the complexity of securely mounting this faucet and the in-floor plumbing necessary, Pelham & White strongly recommends that these products be installed by professionals.

This installation guide covers several models, all installing in the same manner. All images may not appear the same as the product you are installing.

Carefully read this entire installation guide before installing and using this product



#### Parts Identification

1. Spout
2. Aerator
3. Faucet Body
4. Diverter Button
5. Main Tube
6. Floor Escutcheon
7. Supply Hoses (2)
8. Floor Bracket
9. Handshower
10. Handshower Hose

MODELS:  
PW82424  
PW82425  
PW82426

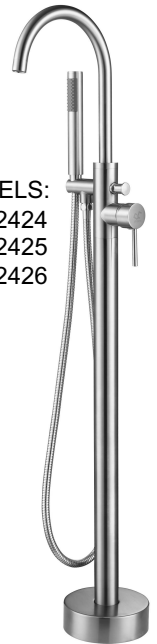

MODELS:  
PW82427  
PW82428  
PW82429

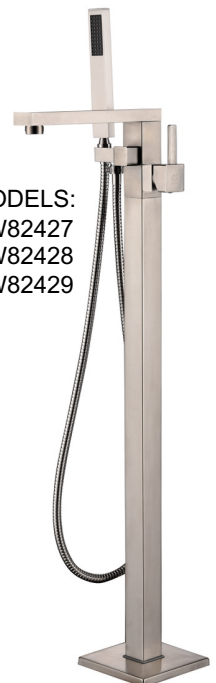

# FAUCET ASSEMBLY

**1**

Slide the Floor Escutcheon (6) over the externally threaded end of the Main Tube (5) as shown

**2**

Screw the Main Tube (5) onto the Floor Bracket (8). Hand-tighten as firmly as possible.

**3**

HOT (Red) COLD (Blue)

Feed the Supply Hoses (7) up through the Main Tube (5) as shown.

**4**

Hand Spray Holder

HOT (Red) COLD (Blue)

Thread the HOT supply hose all the way into the threaded hole in the bottom of the faucet body nearest the hand spray holder, and the COLD supply hose in the far hole. The connections on the Faucet Body are also marked H and C. Hand tighten or apply light torque with pliers. No need to overtighten.

**5**

Connect main tube to faucet body

**ROUND BODIES:**  
Screw the Main Tube (5) onto the Faucet Body (3) and tighten firmly by hand.

**SQUARE BODIES:**  
Slide the Faucet Body (3) fully into the end of Main Tube (5) that has the two setscrews. Orient the faces of the two pieces so that the two setscrews are directed toward where the faucet will be viewed the least. Secure by tightening the two setscrews. Do not over-tighten.

Pelham & White reserves the right to make specification and pricing changes without notice or obligation, and to change or discontinue models and finishes

# MOUNTING FAUCET TO FLOOR

Due to the various materials and conditions that may exist surrounding this installation, it will be the responsibility of the installer to select the location of the faucet, the appropriate fasteners to secure the faucet to the floor, and the roughing-in of the supply piping.

**Be sure to orient the faucet so that the spout is in the correct direction and at the location that will enable the spout to flow water into the tub without hitting the rim of the tub.**

**6**

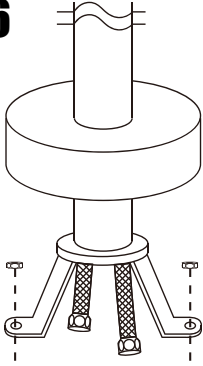

Orient the faucet in correct position in relation to the tub.

Secure the Floor Bracket (8) to the floor using the appropriate fasteners.

**7**



Connect the Supply Hoses (7) to the roughed-in hot and cold piping. Be sure the black rubber washers are in place. The thread on the hose swivel nuts is  $\frac{1}{2}$  x 14TPI.

**8**

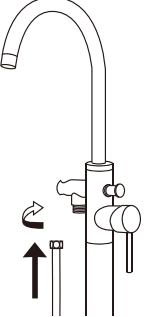

Connect the Handshower Hose (10) to the Faucet Body (3). Be sure the black rubber washer is in place. Hand-tighten as firmly as possible.

Do not connect the Handspray yet.

**9**

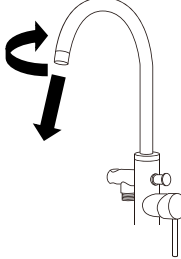

Unscrew and remove the Aerator (2) at the end of the spout.

Turn the faucet off

Place Handshower Hose (10) in an empty bucket and secure.

**10 TEST & FLUSH LINES**

Turn on the water supplies. Check for leaks.

Turn the faucet on (hot and cold) and flush the lines of debris.

Hold the Handshower Hose in a bucket, push the diverter button and flush that line.

**11**

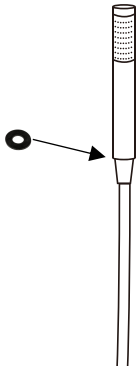

Connect the Handshower Hose (8) to the Handshower (7).

Be sure the black rubber washer is in place. Hand-tighten firmly.

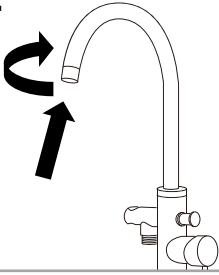
**12**

Re-install the aerator at the end of the spout. Be sure the black rubber washer is in place. Hand-tighten firmly.

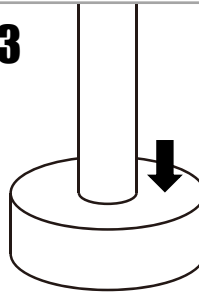
**13**

Slide the Floor Escutcheon (4) down to the floor and seal with silicone caulk.

## WARRANTY

Pelham & White extends a limited lifetime warranty to the initial consumer purchaser, our product to be free from defects in material and workmanship during normal residential use. This warranty do not cover normal wear and tear or damage to the surface caused by the use of chemicals or chlorides. Damage caused by accident, misuse, abuse, or practices not in compliance with the use and care guideline included with the product is not covered by this warranty.

If any defects develop under warranty, Pelham & White will replace the product or defective components. Improper use or installation will immediately void this warranty. No other liability or obligation is to be assumed. Proof of purchase (original sales receipt) from an authorized Pelham & White reseller must be provided for all warranty claims. Pelham & White will not be responsible for labor charges and installation or any other consequential costs. In no event shall the responsibility of Pelham & White exceed the purchase price of the product.

Commercial cleaning products, abrasive cleaners, cleaners containing chlorides, particularly hard water or water with a high iron content can be damaging to the surface and workings of any faucet. To keep your faucet looking it's best, do not allow these materials to remain or dry on the surface of the faucet. Never use abrasive cleaners or cleaners containing bleach. Cleaning with a mild cleaner and a soft cloth is recommended.



PELHAM & WHITE

Pelham & White reserves the right to make specification and pricing changes without notice or obligation, and to change or discontinue models and finishes