



PELHAM & WHITE
 Model: PWW200

MINIMUM CABINET SIZE:
 AT LEAST
33" WIDE

Unpack and inspect your sink upon delivery to avoid costly contractor delays

Product Features

- High quality 16-Gauge 304 stainless steel alloy
- Sound deadening rubber pads and undercoating
- 10mm/0.4" radius corners for easy cleaning
- Includes finish matched stainless steel wire grid
- Includes finish matched stainless steel strainer drain



This sink is intended only for under-counter installations of solid-surface composite or natural stone countertops. It should never be installed in laminated countertops. Thus, specialized tools are required. It is highly recommended that this product be installed by professionals.



Observe all applicable plumbing codes in your municipality

Rough-In Dimensions

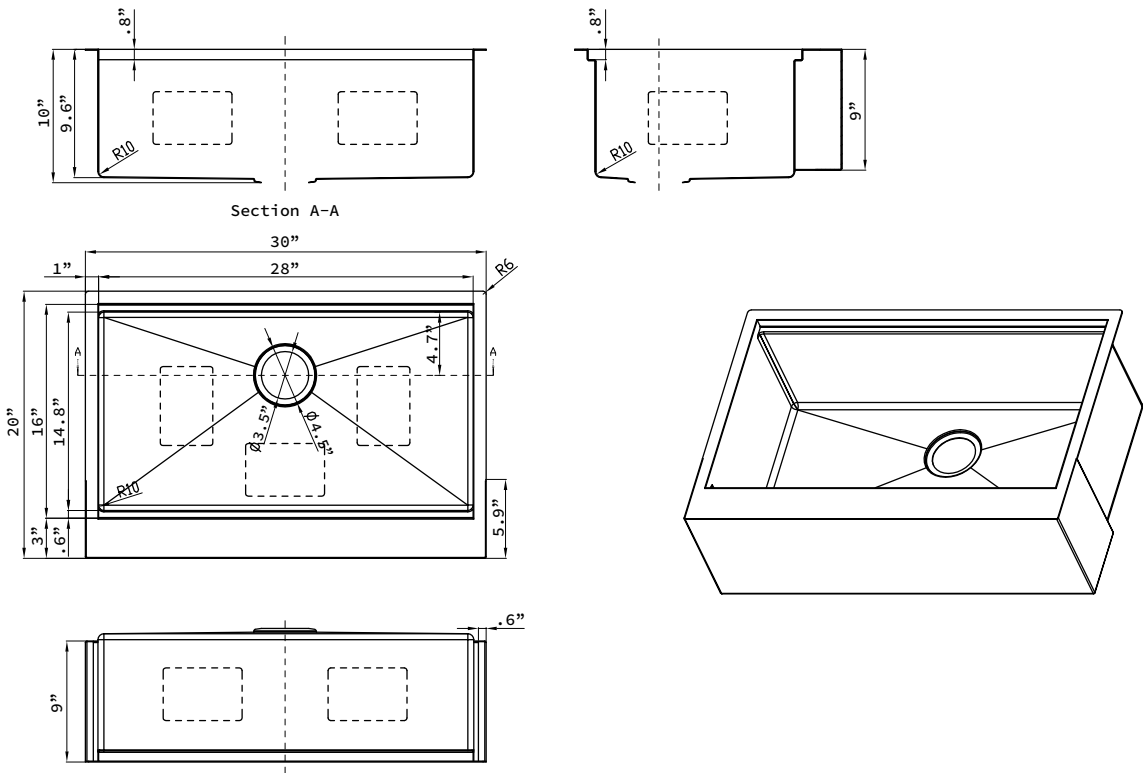



This sink is intended only for under-counter installations of solid-surface composite or natural stone countertops. It should never be installed in laminated countertops. Thus, specialized tools are required. It is highly recommended that this product be installed by professionals.

Installation

Observe all applicable plumbing codes in your municipality

Installer:

- The methods of installation for undermount and apron sinks are highly dependent on the countertop and cabinet materials, construction and dimensions
- If you are unfamiliar with the installation options and techniques for apron-styled sinks please do the proper research given the countertop material and cabinet applications specific to this jobsite
- Template supplied with product is for reference only
- Be sure to double check with the actual sink before cutting opening
- Be sure to properly construct a sturdy wood frame to support the sink and its contents when filled
- Be sure to secure the frame to the cabinet sides
- Silicone adhesive / sealant should be used between the sink and the countertop
- Mounting the faucet to the countertop before installing sink is highly recommended

It is always best to use your own preferred methods of sink securement and attachment, given the different applications and countertop materials that may be involved.

Care

Stainless steel sinks are durable, but they do benefit from proper care. If you want your sink to always look it's best we recommend the following :

- Clean using a non-abrasive, mild detergent.
- Use only a sponge or soft cloth for cleaning.
- Avoid using steel wool for cleaning anything within the sink.
- Remove any cast iron or steel pans promptly after cleaning.
- Keep the sink clean, dry and empty when not in use.
- Don't leave sponges and other wet items in the sink.
- If you want to avoid water spots, wipe your sink dry after each use.

Warranty

Limited lifetime warranty on residential applications or limited one year for commercial applications extended to the original purchaser or owner covering defects in material and workmanship. Excluded is damage done to the surface by disregarding the care recommendations provided in the installation instructions, or improper installation. This warranty does not cover products not installed by a qualified professional installer. Warranty covers replacement of the defective product only and does not cover installation or other consequential costs or damages.

Pelham & White reserves the right to make specification and pricing changes without notice or obligation, and to change or discontinue models and finishes



PELHAM & WHITE

548 South Columbus Avenue • Mount Vernon, New York 10550
1-855-561-5222 • www.pelhamandwhite.com

(09/10/21) All rights reserved. Copyright Pelham & White 2021.